

Low Cost, Single Phase, Adjustable Trip

DESCRIPTION

Model 9993 is a single phase, AC current switch designed for industrial applications. The 9993 has an internal relay with isolated form 1C contacts. The 9993 requires a supply voltage to operate. The current trip point is continuously adjustable from 500 mA to 7 A. The 9993 has a 3/8 inch diameter hole for sensing AC currents through an isolated wire.



SPECIFICATIONS

Sensing Ranges	500 mA to 7 A
Sensor Frequency Range	50 – 60 Hz
Trip Point	Adjustable
Temperature Range	-20°C to 85°C
Maximum Wire Size	3/8"
Dimensions (L x W x H)	2.1 X 1.6 x 1.0 inches
Connections	6-32 Screw Terminals (5)
Operating Voltage	Specify when ordering
Operating Current	2.7 mA normally, 10.5 mA when tripped
Output Type	Mechanical Relay Switch
Load Rating	10 A @ 120 VAC & 28 VDC, 7 A @ 240 VAC
Motor Load Rating	1/3 HP @ 125 VA, 1/2 HP @ 240 VAC

FEATURES

- Encapsulated to prevent environmental and physical damage
- Accommodate wires up to 3/8 inch
- Currents up to 7 A
- Currents as low as 100mA
- Outputs are isolated from monitored lines

APPLICATIONS

- Protects motors
- Increases Motor Life
- Pumping
- Irrigation
- Conveyors
- Loaders
- Fans and Blowers
- Ovens and Heaters
- Waste Management
- Material Handling
- Industrial Process Control

ORDERING

Series	Operating Voltage	
9993	A → 120VAC	
	B → 5VDC	
	C → 12VDC	
	D → 24VDC	More current ranges are also available.
	E → 48VDC	Contact us for more information.
	F → 3VDC†	† Special Order

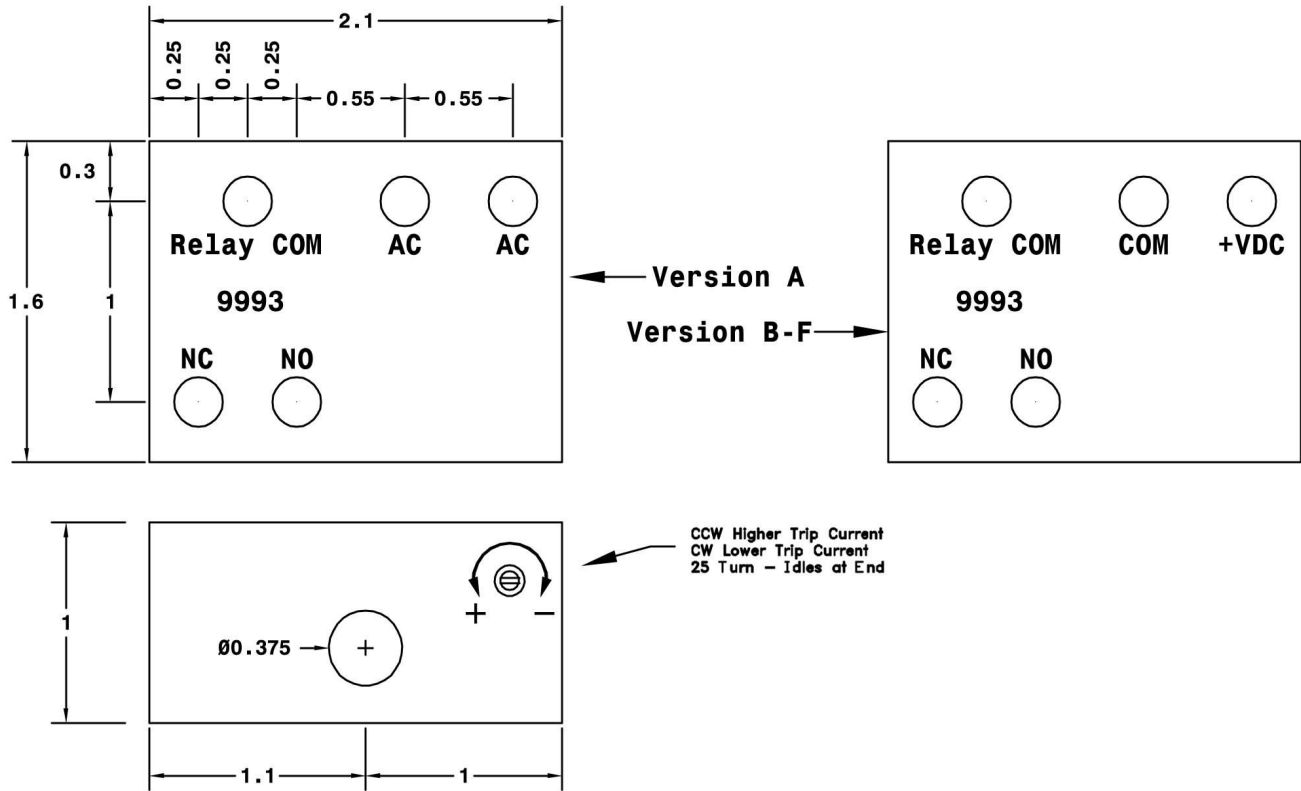

Typical Connections

